

# TASCAM

TEAC Professional Division

D00808300A

# CD-RW750

## CD Rewritable Recorder



### Professional

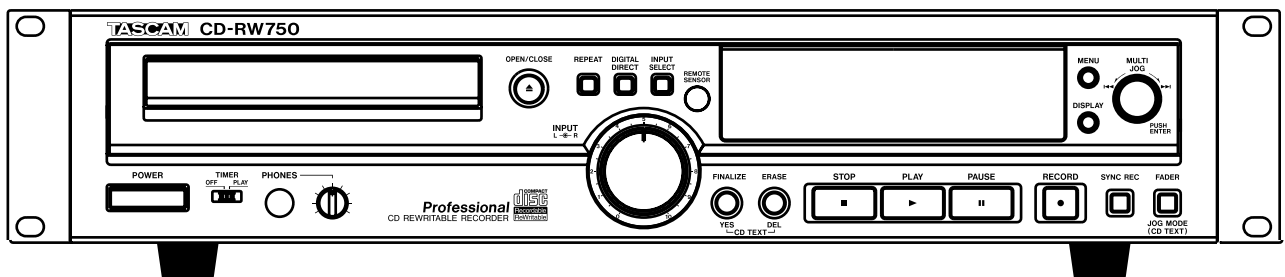

## OWNER'S MANUAL



**CAUTION**  
RISK OF ELECTRIC SHOCK  
DO NOT OPEN



**CAUTION:** TO REDUCE THE RISK OF ELECTRIC SHOCK, DO NOT REMOVE COVER (OR BACK). NO USER-SERVICEABLE PARTS INSIDE. REFER SERVICING TO QUALIFIED SERVICE PERSONNEL.



The lightning flash with arrowhead symbol, within an equilateral triangle, is intended to alert the user to the presence of uninsulated "dangerous voltage" within the product's enclosure that may be of sufficient magnitude to constitute a risk of electric shock to persons.



The exclamation point within an equilateral triangle is intended to alert the user to the presence of important operating and maintenance (servicing) instructions in the literature accompanying the appliance.

This appliance has a serial number located on the rear panel. Please record the model number and serial number and retain them for your records.  
Model number \_\_\_\_\_  
Serial number \_\_\_\_\_

**WARNING: TO PREVENT FIRE OR SHOCK HAZARD, DO NOT EXPOSE THIS APPLIANCE TO RAIN OR MOISTURE.**

## IMPORTANT SAFETY INSTRUCTIONS

- 1 Read these instructions.
- 2 Keep these instructions.
- 3 Heed all warnings.
- 4 Follow all instructions.
- 5 Do not use this apparatus near water.
- 6 Clean only with dry cloth.
- 7 Do not block any ventilation openings. Install in accordance with the manufacturer's instructions.
- 8 Do not install near any heat sources such as radiators, heat registers, stoves, or other apparatus (including amplifiers) that produce heat.
- 9 Do not defeat the safety purpose of the polarized or grounding-type plug. A polarized plug has two blades with one wider than the other. Grounding type plug has two blades and a third grounding prong. The wide blade or the third prong are provided for your safety. If the provided plug does not fit into your outlet, consult an electrician for replacement of the obsolete outlet.
- 10 Protect the power cord from being walked on or pinched, particularly at plugs, convenience receptacles, and the point where they exit from the apparatus.
- 11 Only use attachments/accessories specified by the manufacturer.
- 12 Use only with the cart, stand, tripod, bracket, or table specified by the manufacturer or sold with the apparatus. When a cart is used, use caution when moving the cart/apparatus combination to avoid injury from tip-over.
- 13 Unplug this apparatus during lightning storms or when unused for long periods of time.
- 14 Refer all servicing to qualified service personnel. Servicing is required when the apparatus has been damaged in any way, such as power-supply cord or plug is damaged, liquid has been spilled or objects have fallen into the apparatus, the apparatus has been exposed to rain or moisture, does not operate normally, or has been dropped.
  - Do not expose this apparatus to drips or splashes.
  - Do not place any objects filled with liquids, such as vases, on the apparatus.
  - Do not install this apparatus in a confined space such as a book case or similar unit.



## IMPORTANT (for U.K. Customers)

DO NOT cut off the mains plug from this equipment.

If the plug fitted is not suitable for the power points in your home or the cable is too short to reach a power point, then obtain an appropriate safety approved extension lead or consult your dealer.

If nonetheless the mains plug is cut off, remove the fuse and dispose of the plug immediately, to avoid a possible shock hazard by inadvertent connection to the mains supply.

If this product is not provided with a mains plug, or one has to be fitted, then follow the instructions given below:

**IMPORTANT: DO NOT** make any connection to the larger terminal which is marked by the letter E or by the safety earth symbol  $\perp$  or coloured GREEN or GREEN-and-YELLOW.

The wires in this mains lead are coloured in accordance with the following code:

**BLUE** : **NEUTRAL**

**BROWN** : **LIVE**

As the colours of the wires in the mains lead of this apparatus may not correspond with the coloured markings identifying the terminals in your plug proceed as follows:

The wire which is coloured BLUE must be connected to the terminal which is marked with the letter N or coloured BLACK.

The wire which is coloured BROWN must be connected to the terminal which is marked with the letter L or coloured RED.

When replacing the fuse only a correctly rated approved type should be used and be sure to re-fit the fuse cover.

IF IN DOUBT — CONSULT A COMPETENT ELECTRICIAN.

For U.S.A.

### TO THE USER

This equipment has been tested and found to comply with the limits for a Class A digital device, pursuant to Part 15 of the FCC Rules. These limits are designed to provide reasonable protection against harmful interference when the equipment is operated in a commercial environment. This equipment generates, uses, and can radiate radio frequency energy and, if not installed and used in accordance with the instruction manual, may cause harmful interference to radio communications.

Operation of this equipment in a residential area is likely to cause harmful interference in which case the user will be required to correct the interference at his own expense.

### CAUTION

Changes or modifications to this equipment not expressly approved by TEAC CORPORATION for compliance could void the user's authority to operate this equipment.

### For the consumers in Europe

#### WARNING

This is a Class A product. In a domestic environment, this product may cause radio interference in which case the user may be required to take adequate measures.

### Pour les utilisateurs en Europe

#### AVERTISSEMENT

Il s'agit d'un produit de Classe A. Dans un environnement domestique, cet appareil peut provoquer des interférences radio, dans ce cas l'utilisateur peut être amené à prendre des mesures appropriées.

### Für Kunden in Europa

#### Warnung

Dies ist eine Einrichtung, welche die Funk-Entstörung nach Klasse A besitzt. Diese Einrichtung kann im Wohnbereich Funkstörungen verursachen; in diesem Fall kann vom Betreiber verlangt werden, angemessene Maßnahmen durchzuführen und dafür aufzukommen.

# SAFETY INFORMATION

## SAFETY INFORMATION

This product has been designed and manufactured according to FDA regulations "title 21, CFR, chapter 1, subchapter J, based on the Radiation Control for Health and Safety Act of 1968", and is classified as a class 1 laser product. There is no hazardous invisible laser radiation during operation because invisible laser radiation emitted inside of this product is completely confined in the protective housings. The label required in this regulation is shown in ①.

## CAUTION

- DO NOT REMOVE THE PROTECTIVE HOUSING USING A SCREWDRIVER.
- USE OF CONTROLS OR ADJUSTMENTS OR PERFORMANCE OF PROCEDURES OTHER THAN THOSE SPECIFIED HEREIN MAY RESULT IN HAZARDOUS RADIATION EXPOSURE.
- IF THIS PRODUCT DEVELOPS TROUBLE, CONTACT YOUR NEAREST QUALIFIED SERVICE PERSONNEL, AND DO NOT USE THE PRODUCT IN ITS DAMAGED STATE.

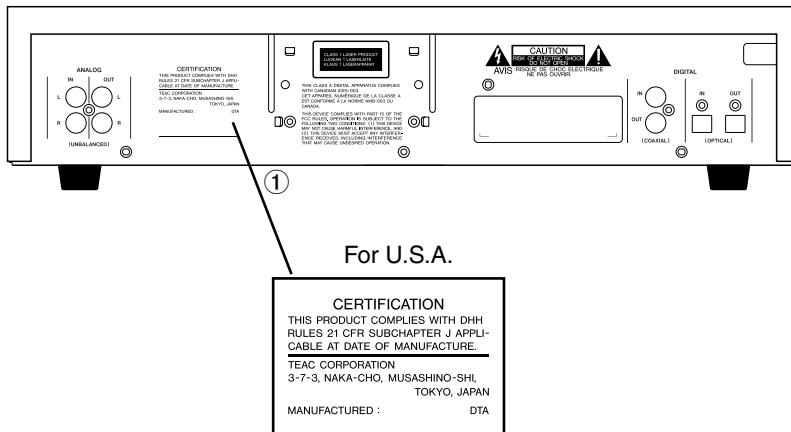

### Optical pickup:

Type	: SF-W03PDX
Manufacturer	: SANYO Electric Co. Ltd.
Laser output	: Less than 40mW on the objective lens
Wavelength	: 783 ±3nm

<b>1 – Introduction</b>	
About CD-R and CD-RW discs.....	6
Finalizing.....	7
"Recordable" discs.....	7
About this manual.....	7
Unpacking the CD-RW750.....	7
Rack-mounting the unit.....	8
Environmental considerations.....	8
Beware of condensation.....	8
Never use a stabilizer or printable discs.....	8
Handling of compact discs.....	9
Additional notes with regard to CD-R and CD-RW discs.....	9
Default values.....	10
<b>2 – Features of the CD-RW750</b>	
Front panel.....	11
Rear panel.....	12
RC-RW750 Remote control unit.....	13
Use of the remote control unit.....	14
Connections.....	14
Using the timer function.....	14
<b>3 – Playback operations</b>	
Simple playback operations.....	15
Time display modes.....	15
Track search.....	16
Playback modes.....	16
Programmed order playback.....	17
Repeat play.....	17
A-B repeat mode.....	17
<b>4 – Recording</b>	
Input selection.....	18
Input monitoring.....	18
Frequency conversion.....	18
Basic recording.....	19
Playing back tracks.....	19
Time display while recording.....	19
Manual track division.....	20
Full disc.....	20
Advanced recording.....	20
Synchronized recording.....	20
Sync recording (start).....	21
Sync recording (stop).....	21
Setting the trigger level.....	22
Automatic track division.....	22
Digital direct.....	23
Rec mute function.....	23
Fade-in and fade-out.....	23
<b>5 – After recording</b>	
Finalizing.....	25
Unfinalizing CD-RW discs.....	25
Erasing.....	25
Erasing tracks.....	26
Erasing a whole disc.....	26
Refreshing a disc.....	26
Titling (CD TEXT).....	27
<b>6 – Reference and specifications</b>	
Troubleshooting.....	28
Specifications.....	28
Audio performance.....	28
Audio specifications.....	29
Physical specifications.....	29
Dimensional drawing.....	29

# 1 – Introduction

The TASCAM CD-RW750 CD rewritable recorder allows you to make your own CDs from a variety of sources—other CDs, MD recordings, analog cassette tapes, and records.

Tracks can be recorded all at one time, or added, until the disc is “finalized”, allowing it to be played on CD players.

## NOTE

*Some models of CD player may be unable to play certain discs produced using the CD-RW750.*

A variety of sophisticated features are incorporated in the CD-RW750, allowing a wide degree of flexibility.

The CD-RW750 provides analog unbalanced audio inputs and outputs for connection to –10dBV equipment.

In addition, coaxial and optical inputs and outputs are provided for recording from and playing back to suitably-equipped digital audio equipment.

24-bit digital-to-analog and analog-to-digital converters provide excellent recording and playback quality.

A sampling frequency converter is incorporated, allowing the recording of CDs from digital audio sources which are at frequencies other than the CD standard sampling frequency of 44.1 kHz.

Track divisions can be entered manually, or can be produced automatically as a response to the input signal level.

A recording buffer ensures that even the first milliseconds of a track are recorded.

“One-touch” fade-ins and fade-outs over a specified time allow you to edit program material to your specific requirements.

A multi-function “multi jog” dial is used to set and confirm parameter settings as well as to enable entry of CD TEXT titles, etc.

A wireless remote control unit allows control of the CD-RW750 from remote locations.

## NOTE

*This product is designed to help you record and reproduce sound works to which you own the copyright, or where you have obtained permission from the copyright holder or the rightful licensor. Unless you own the copyright, or have obtained the appropriate permission from the copyright holder or the rightful licensor, your unauthorized recording, reproduction or distribution thereof may result in severe criminal penalties under copyright laws and international copyright treaties. If you are uncertain about your rights, contact your legal advisor. Under no circumstances will TEAC Corporation be responsible for the consequences of any illegal copying performed using the CD-RW750.*

---

## About CD-R and CD-RW discs

---

The CD-RW750 uses CD-R and CD-RW media, and can also use CD-R and CD-RW Digital Audio media.

CD-R discs can be recorded once only. Once they have been used for recording, they cannot be erased or re-recorded. However, if space is available on the disc, additional material can be recorded. The packaging of CD-R discs will include one of the following logos:



By contrast, a CD-RW disc can be used in much the same way as a CD-R disc, but the last track or tracks recorded can be erased before the disc has been “finalized”, and the space on the disc can be re-used

for other recordings. The packaging of CD-RW discs will include the logo one of the following logos:



However, you should note that an audio CD created using a CD-RW disc may not play back satisfactorily on every audio CD player. It will, naturally, be playable on the CD-RW750. This is in no way a limitation of the CD-RW750 itself, but of the difference between the different types of media and the methods used to read them.

CD-R discs created on the CD-RW750, by contrast, may be played satisfactorily on the majority of audio CD players.

---

## Finalizing

---

Although audio data may be written on a CD-R or CD-RW disc, a standard CD player will not be able to read the data (i.e. play back the audio) until a final table of contents (TOC) has been written at the start of the disc.

The process of writing this table of contents is known as “finalizing”. Once this has been done, no further data can be written to the disk. See “Finalizing” on page 25 for details.

In the case of a CD-RW disc which has been finalized, the whole of the disc may be erased, or the disc may be “refreshed”, and the disc re-used.

In addition, a CD-RW disc that has been finalized may be “unfinalized”, i.e. only the TOC is removed. This allows further tracks to be recorded to the disc, provided that there is space on the disc.

---

## “Recordable” discs

In this manual, we use the term “recordable” disc to describe a CD-R or CD-RW disc that has not been finalized, i.e. further recording is possible on the disc.

---

## About this manual

In this manual, we use the following conventions:

- The names of keys and controls are given in the following typeface: **ERASE**.
- When the alphanumeric portion of the display shows a message, this is shown in the following typeface: `Welcome`.
- If a preset indicator in the display (i.e. one which cannot change, but is either on or off) is shown, this is shown as follows: SHUFFLE.

- When referring to a front or rear panel control or feature, the following typeface is used to show the number of the feature (as given in the diagram in this manual, and the corresponding explanation): ⑤.
- When referring to a remote control key, the following typeface is used to show the number of the key (as given in the diagram in this manual, and the corresponding explanation): ⑤.

---

## Unpacking the CD-RW750

---

When unpacking the unit, you should find the following items, in addition to this manual:

- The main unit itself
  - The remote control unit
  - Two AAA batteries for the remote control unit
  - A rack-mounting screw kit (screws and washers)
- Contact your TASCAM supplier if any of these items are missing.

# 1 – Introduction

## Rack-mounting the unit

Use the rack-mounting kit to mount the unit in a standard 19-inch equipment rack, as shown below. Remove the feet of the unit before mounting it.

If you are mounting the unit in a rack, leave 1U of space above it.

See “Environmental considerations” on page 8 below for details of ventilation, etc.

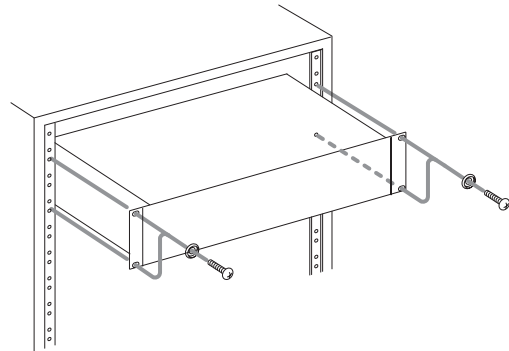

## Environmental considerations

The CD-RW750 may be used in most areas, but to maintain top performance, and prolong operating life, observe the following environmental conditions:

The nominal temperature should be between 5°C and 35°C (41°F and 95°F). The CD-RW750 is more sensitive to extremes of temperature than ordinary CD players.

Relative humidity should be 30 to 90 degrees non-condensing.

As the unit may become hot during operation, always leave sufficient space above the unit for ventilation.

Do not install this apparatus in a confined space such as a book case or similar unit.

Make sure that the unit is mounted in a level position for correct operation. Do not mount the unit in a rack tilted 5° or more from the vertical position.

### NOTE

*If the mounting surface is more than 5 degrees away from the horizontal, the tray will not open or close.*

The voltage supplied to the unit should match the voltage as printed on the rear panel. If you are in any doubt regarding this matter, consult an electrician.

### NOTE

*When transporting the unit, always use the original packing materials. For this reason, we strongly recommend that you save all the packing materials that came with the CD-RW750, in case you need to transport it in the future.*

*In addition, when transporting the unit, you should tape the disc tray closed, using an adhesive tape that will not spoil the finish of the unit.*

## Beware of condensation

If the unit (or a compact disc) is moved from a cold to a warm place, or used after a sudden temperature change, there is a danger of condensation; vapor in the air could condense on the internal mechanism,

making correct operation impossible. To prevent this, or if this occurs, leave the player for one or two hours with the power turned on, then turn the power off and on again.

## Never use a stabilizer or printable discs

Using commercially available CD stabilizers or printable recordable discs with this player will damage the mechanism and cause it to malfunction.

### NOTE

*Never use a disc that has had a stabilizer mounted to it. The residual adhesive may cause the disc to stick to the turntable of the CD-RW750. If it sticks to the turntable, you will need a technician to get it out.*



## Handling of compact discs

Observe the following:

- Always place the compact discs in the trays with their label facing upward (compact discs can only be played on one side).
- To remove a disc from its storage case, press down on the center of the case, and lift the disc out, holding it carefully by the edges.



- Finger marks and dust should be carefully wiped off the disc's recorded surface with a soft cloth. Unlike conventional records, the compact disc has no grooves to collect dust and microscopic debris, so gently wiping with a soft cloth should remove most particles.
- Wipe in a straight motion from the inside to the outside of the disc. Small dust particles and light

stains will have absolutely no effect on reproduction quality.



- Never use such chemicals as record sprays, anti-static sprays or fluid, benzine or thinner to clean compact discs. Such chemicals will do irreparable damage to the disc's plastic surface.
- Discs should be returned to their cases after use to avoid serious scratches that could cause the laser pickup to "skip".
- Don't expose discs to direct sunlight or high humidity and temperature for extended periods. Long exposure to high temperature can warp the disc.
- Only use circular compact discs. Avoid using non-circular promotional, etc. discs.

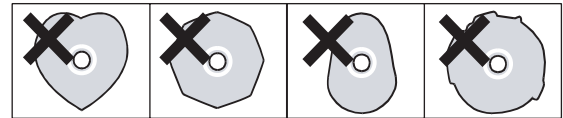

- To keep the laser pickups clean, don't touch them. For the same reason, don't leave the disc trays opened unnecessarily.

## Additional notes with regard to CD-R and CD-RW discs

There are additional precautions that you should take when handling CD-R and CD-RW discs, that are different to those that you should take when handling ordinary CDs.

- Avoid touching the recording (non-label) side of a disc on which you will be recording. Recording on a disc requires a cleaner surface than playing back, and fingerprints, grease, etc. can cause errors in the recording process.
- CD-R discs are more sensitive to the effects of heat and ultraviolet rays than ordinary CDs. It is important that they are not stored in a location where direct sunlight will fall on them, and which is away from sources of heat such as radiators or heat-generating electrical devices.

- Always store CD-R discs in their "jewel cases" to avoid dirt and dust accumulating on their surfaces.
- Do not put labels or protective sheets on the discs and do not use any protective coating spray.
- When labeling CD-R discs, always use a soft oil-based felt-tipped pen to write the information. Never use a ball-point or hard-tipped pen, as this may cause damage to the recorded side.
- Dirty discs may be cleaned using a soft dry cloth and/or a commercial CD cleaning fluid or ethyl alcohol. Do not use thinner, gasoline, benzene or LP cleaning fluid, as these will damage the disc.
- If you are in any doubt as to the care and handling of a CD-R disc, read the precautions supplied with the disc, or contact the disc manufacturer directly.

# 1 – Introduction

## Default values

The default values of the unit's settings when the unit is shipped from the factory are given below:

Setting	Description	Default value
Digital direct (D_DIRECT)	"Digital direct" on page 23	Off
Input selection	"Input selection" on page 18	Analog
Auto track (A_TRACK)	"Automatic track division" on page 22	On
Trigger level (S_LEVEL)	"Synchronized recording" on page 20	-54 dB
FADE IN time	"Fade-in and fade-out" on page 23	3 seconds
FADE OUT time	"Fade-in and fade-out" on page 23	3 seconds
Volume (DIGITAL IN)	"Input selection" on page 18	0 dB
Play mode	"Playback modes" on page 16	Continue

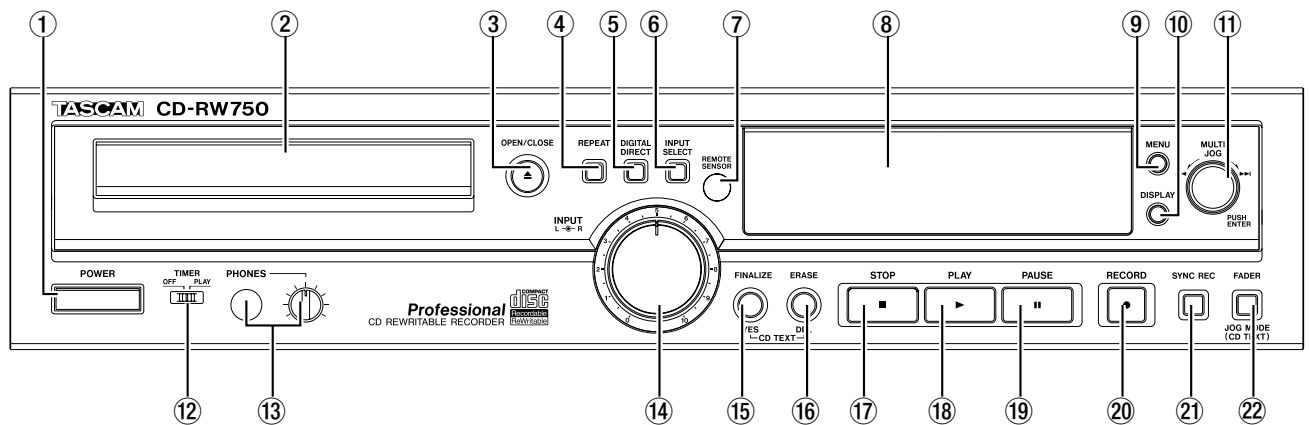

### Front panel

① **POWER switch** The power switch is used to switch the unit on and off.

When the unit is turned on, the display shows *Welcome!*.

② **Disc tray** Discs should be placed label side upwards in the disc tray.

When a disc is loaded into the unit, the display briefly shows *TOC Reading.*, with a flashing period following the word “Reading” as the unit determines the contents of the disc.

③ **OPEN/CLOSE key** Use this key to open and close the disc tray. The display shows *OPEN* when the tray is opening and *CLOSE* when the tray is closing.

④ **REPEAT key** Use this key to set the different repeat modes available.

⑤ **DIGITAL DIRECT** When this is active, any digital audio signals input to the unit bypass the frequency converter and the digital volume control. See “Digital direct” on page 23 for details.

⑥ **INPUT SELECT** Repeated presses of this key cycle through the different audio inputs and the input combinations. See “Input selection” on page 18 for full details.

⑦ **REMOTE SENSOR** This is not a control, but the sensor for the remote control unit. When using the remote control unit, make sure that there is a clear path from the remote control unit to the sensor.

⑧ **Display** The display is used to show the current status of the unit, as well as the current menu settings.

⑨ **MENU key** Repeated presses of this key cycle through the different menu items used to set parameters.

⑩ **DISPLAY key** Repeated presses of this key cycle through the different time display modes. These modes differ, according to whether the unit is playing back or recording a disc.

⑪ **MULTI JOG control** Use this control to select tracks for playback, to set parameter values, and to set the titles of discs and tracks, etc.

Typically, turning the control clockwise will increase a value, and turning it counterclockwise will decrease the value. There is no “end-stop” to the control—it may be turned continuously in either direction.

In addition, pushing the control acts like an “enter” key, i.e. the currently-displayed value or setting is confirmed.

⑫ **TIMER switch (PLAY, OFF)** Use this switch to control the behavior of the unit when power is switched on. See “Using the timer function” on page 14 for details.

⑬ **PHONES jack and LEVEL control** Use a standard pair of stereo headphones, equipped with a 1/4-inch plug, with this jack.

Adjust the volume from the jack with the control (turn clockwise for higher volume).

⑭ **INPUT controls** Use these concentric controls to adjust the level of the analog audio signals received at the **ANALOG IN** jacks (23). Typically, turning one of these controls will cause the other to turn, but they can be turned independently of each other.

## 2 – Features of the CD-RW750

Use the lower (outer) control to adjust the left signal, and the upper (inner) control to adjust the right signal.

Turning the controls clockwise past the “5” position will boost the signals relative to their input level, and turning them counterclockwise to a position below “5” will cut the signals relative to their original input level.

⑮ **FINALIZE key** Use this key to finalize recordable discs. See “Finalizing” on page 7 and “Finalizing” on page 25 for details.

It also acts as a confirm key when entering CD TEXT data (see “Titling (CD TEXT)” on page 27).

⑯ **ERASE key** Use this key (with CD-RW discs only) to erase tracks, or a whole disc, or to refresh a “bad” disc, or to unfinalize a finalized disc. See “Erasing” on page 25 for details.

It also acts as a delete key when entering CD TEXT data (see “Titling (CD TEXT)” on page 27).

⑰ **STOP key** Use this key to stop playback or recording.

⑱ **PLAY key** Use this key to start or resume playback or recording.

⑲ **PAUSE key** Use this key to pause playback or recording.

⑳ **RECORD key** Use this key to enter record ready mode (see “Recording” on page 18 for details) and also to enter manual track divisions (see “Manual track division” on page 20).

㉑ **SYNC REC key** Use this key to turn synchronized recording on and off before starting to record (see “Synchronized recording” on page 20 for details).

㉒ **FADER key** Use this key to start fade-in recordings or to start a fade-out when recording (see “Fade-in and fade-out” on page 23 for details).

It also changes the mode of the **MULTI JOG** control between data entry and cursor when entering CD TEXT data (see “Titling (CD TEXT)” on page 27).

### Rear panel

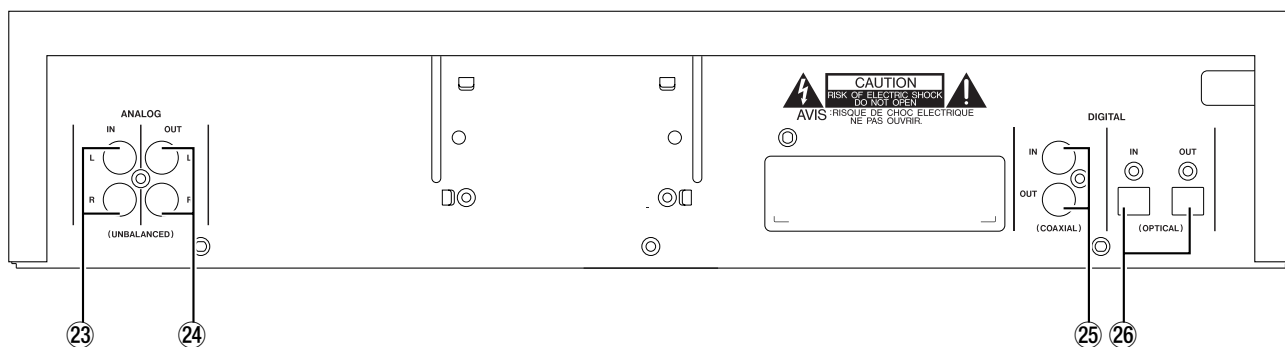

⑳ **ANALOG IN (L, R)** These RCA jacks accept analog audio signals from suitably-equipped units (–10dBV, unbalanced).

㉑ **ANALOG OUT (L, R)** These RCA jacks output analog audio signals (at –10dBV levels, unbalanced) to suitably-equipped units.

㉒ **DIGITAL COAXIAL (IN, OUT)** These two RCA jacks accept and output digital audio in standard consumer format (SPDIF).

㉓ **DIGITAL OPTICAL (IN, OUT)** These two TOSLINK optical connectors accept and output digital audio using optical fiber connectors.

## RC-RW750 Remote control unit

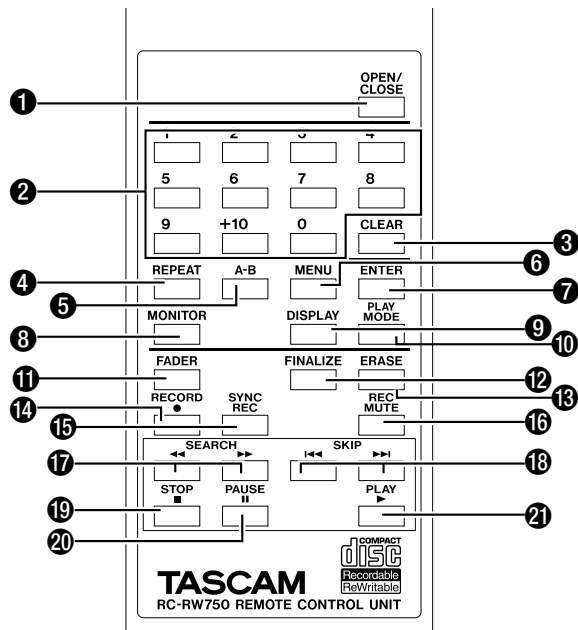

**1 OPEN/CLOSE key** Opens and closes the disc tray (equivalent to ③).

**2 Number keys (0 through 10 and +10)** Use these keys for direct entry of track numbers when playing back, or making a programmed play list.

**3 CLEAR key** Use this key to clear a mistaken entry made with the number keys.

**4 REPEAT key** Use this key to change between the various repeat modes when playing back (see “Repeat play” on page 17).

**5 A-B key** Use this key to set the A-B repeat points and playback mode (see “A-B repeat mode” on page 17).

**6 MENU key** Repeated presses of this key cycle through the different menu items used to set parameters (equivalent to ⑨).

**7 ENTER key** Pressing this key is equivalent to pressing the **MULTI JOG** control ⑪ to confirm an entry.

**8 MONITOR key** Use this key to output the signals received at the currently selected input(s)

through the outputs when not recording or in record ready mode.

**9 DISPLAY key** Use this key to switch between the different display modes available (equivalent to ⑩).

**10 PLAY MODE key** Use this key to choose between the different playback modes (single play, continue play, etc.).

**11 FADER key** Use this key to start fade-in recordings or to start a fade-out when recording (equivalent to ⑫).

**12 FINALIZE key** Use this key to finalize recordable discs. See “Finalizing” on page 7 and “Finalizing” on page 25 for details (equivalent to ⑮).

**13 ERASE key** Use this key (with CD-RW discs only) to erase tracks, or a whole disc, or to refresh a “bad” disc, or to unfinalize a finalized disc. See “Erasing” on page 25 for details (equivalent to ⑯).

**14 RECORD key** Use this key to enter record ready mode (equivalent to ⑳).

**15 SYNC REC key** Use this key to turn synchronized recording on and off (equivalent to ㉑). See “Synchronized recording” on page 20 for details.

**16 REC MUTE key** Use this key when recording, to mute the input signal for about four seconds and then to enter record ready mode (see “Rec mute function” on page 23).

**17 SEARCH keys** Use these keys to move the playback position inside a track.

**18 SKIP keys** Use these keys to move between tracks when playing back (equivalent to turning ⑪). They are also used to set the parameter values, etc.

**19 STOP key** Use this key to stop playback or recording (equivalent to ⑰).

**20 PAUSE key** Use this key to pause playback or recording (equivalent to ⑱).

**21 PLAY key** Use this key to start playback, or enter record mode from record ready mode (equivalent to ⑱).

## 2 – Features of the CD-RW750

### Use of the remote control unit

When using the RC-RW750 remote control unit, make sure:

- There is a clear unobstructed path between the remote control unit and the remote sensor (7) on the main unit.
- The remote control unit is located within 5 m (15 ft.) of the main unit, and is pointing at approximately right angles ( $\pm 30^\circ$ ) to the front panel.

When fitting or replacing the batteries:

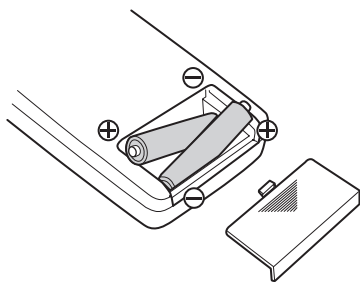

- Always make sure that both batteries are replaced together. Do not mix old and new batteries.
- Do not mix batteries of different types.
- Always make sure that the batteries are located with the correct polarity (the positive terminals of the batteries should match the + markings inside the battery compartment, and the negative terminals should match the - markings).
- If you are not going to use the remote control unit for an extended period of time, remove the batteries. Old batteries can leak, causing damage to the remote control unit.
- Always dispose of old batteries in the way recommended by your local garbage disposal authorities.

### Connections

The following should be noted when you connect the unit to other equipment.

It is possible to connect the unit's **DIGITAL COAXIAL IN** (25) and **DIGITAL OPTICAL IN** (26) to other equipment at the same time. However, the unit can receive signals from only one digital input at a time.

Audio signals output from the unit are output from the analog **ANALOG OUT** (24) jacks, as well as from the **DIGITAL COAXIAL OUT** jack (25) and **DIGITAL OPTICAL OUT** connector (26) simultaneously (but not from the digital outputs in stop mode).

### Using the timer function

You can set the CD-RW750 to start playback when it is switched on (for example, from an external timer). To do this, slide the **TIMER** switch (12) to the **PLAY** position.

When the unit is turned on it will start playing from the start of the loaded disc.

The CD-RW750 can be used to play back CDs (including CD-R and CD-RW discs that have been recorded and finalized on other types of recorder), as

well as CD-R discs and CD-RW discs that have been recorded on the unit.

### Simple playback operations

- 1 Press the **OPEN/CLOSE** key (③ or ❶) to open the disc tray.
- 2 Discs should be inserted in the tray with the label uppermost.
- 3 Press the **OPEN/CLOSE** key (③ or ❶) to close the tray again.

When a disc is loaded into the unit, the display briefly shows **TOC Reading.**, with a flashing period following the word “Reading” as the unit determines the contents of the disc. When the TOC has been read, the display shows the total running time of the disk, followed by the disc title (if the disc contains CD TEXT information), followed by the total running time.

If the title of the disc is more than 12 characters long (a disc title can be up to 23 characters long), only the first 12 characters are displayed.

The first 12 characters of the disc title are also shown (for three seconds) when playback is stopped.

In stop mode, no digital output is possible (see “Input monitoring” on page 18).

The CD-RW750 also shows (at the top left of the display) one of the following:

CD	A commercial pre-recorded CD or a finalized CD-R
CD-R, NO TOC	A CD-R which has yet to be finalized
CD-RW, NO TOC	A CD-RW which has yet to be finalized
CD-RW	A finalized CD-RW (this differs from a CD, as it may be unfinalized and erased)
[blank]	Unusable or unreadable disc or no disc

- 1 Press the **PLAY** key (Ⓜ or ❷) to start playback
- 2 Press the **STOP** key (Ⓜ or ❸) to stop playback
- 3 Press the **PAUSE** key (Ⓜ or ❹) to pause playback temporarily.

The track number indicators at the bottom of the display light, to show the available unplayed tracks. If there are thirteen tracks on the disc, for example, indicators 1 through 13 will light. If there are more than 20 tracks on a disc, the track number **OVER** indicator (at the bottom of the display) will light.

**Track titles** If the finalized disc contains CD TEXT information, the first 12 characters of the track title (track titles can be up to 23 characters in length) are shown for about two seconds, about three seconds into the track.

### Time display modes

When playing back a CD (or in pause mode), there are five different display modes.

In each time mode, the current track number is given, followed by the time, as given below, e.g.

10Tr 0:48

Press the **DISPLAY** key (Ⓜ or ) to cycle through these time display modes, as described below:

Display shows	Meaning
TOTAL	Total elapsed time of the disc
[blank]	Elapsed time of the current track
TOTAL REMAIN	Time remaining of the current disc
REMAIN	Time remaining of the current track
[track title]	If the disc contains CD TEXT information, the current track title is shown. If the title is longer than 12 characters, it scrolls across the display.

#### NOTE

*If programmed playback has been selected (“Programmed order playback” on page 17), the elapsed time and total remaining time refer to the programmed material, not the whole disc.*

## 3 – Playback operations

**Full disc title** When playback is stopped, pressing the **DISPLAY** key switches between showing the total running time of the disc and the disc title (if the finalized disc contains CD TEXT information). If the title is longer than 12 characters, it scrolls across the display.

### Track search

Use the **MULTI JOG** control (11) or the **SKIP** keys on the remote control unit (18) to jump forward or backward by one track at a time, as shown on the display.

Note that going forward from the last track of the disc will “wrap round” to track 1, and going backward from the first track of the disc will “wrap round” to the last track of the disc.

The track number indicators at the bottom of the display shows the selected track (the lit indicator at the left of the row of indicators).

It is also possible to use the number keys on the remote control unit (2) to jump directly to a particular track:

Note that only titles containing alphabetic and numeric characters can be displayed (and entered) using the CD-RW750. Only one title per disc or track may be displayed or entered (i.e. artist names cannot be entered separately).

- 1 To play tracks 1 through 9, simply press the appropriate key (1 through 9).
- 2 To play a track whose number is higher than 9, press the +10 key an appropriate number of times to set the “tens” digit of the track number, followed by a single key to set the “units” digit. For example:

Track 13 = +10, 3

Track 30 = +10, +10, +10, 0

#### NOTE

On the remote control unit only, the **SEARCH** keys (17) can be used to “fast-forward” and “fast-rewind” through the disc.

### Playback modes

The unit can be set to play back a single track, the whole disc in the order in which it was created, the tracks of the disc in a random (shuffled) order, or a programmed order (see “Programmed order playback” on page 17).

#### NOTE

Selecting the playback mode is only possible using the remote control unit. It is not possible to select the playback mode using the main unit alone.

- 1 Press the **PLAY MODE** key (10) repeatedly to cycle the display through the following:

- **Continue**. Normal playback mode. Programming is cancelled, and playback continues in the normal order.
- **Single**. The current track is played back from the start of the track, and playback stops at the end of the track. Note that the **REPEAT ALL** function is not available when this playback mode is selected.

- **Shuffle** (random track order). In this mode, each track is played once before the disc repeats. Using the track search functions will move backwards or forwards through the random order, e.g. if track 7 is followed by track 10, it is possible to use the track search keys to go back to track 7, which is remembered as being before immediately before track 10. The red **SHUFFLE** display indicator lights in this mode.
- **Program** (see “Programmed order playback” on page 17 below). The red **PROGRAM** display indicator lights in this mode.

The selected mode is shown in large characters disappears from the display a few seconds after selecting the mode, and the display returns to its previous mode

The selected playback mode (other than Program mode) is memorized and recalled when power is turned off and on again.



## Programmed order playback

The steps to set up to 32 program steps (tracks) to be played back in a specified order are as follows:

- 1 Press the **PLAY MODE** key (10) until the display shows `Program`.
- 2 The display changes to show  
`0Tr 0:00 00`,  
meaning that no program steps have yet had tracks assigned to them.
- 3 Use the number keys to enter a track number (including the +10 key to enter values greater than 9, as described in “Track search” on page 16). There is no need to press **ENTER**.  
  
The track entered is assigned to the program step, and the display changes, showing the track number, the total time of the program so far, and the step number, e.g.  
`2Tr14:56 03`.
- 4 The next program step can then be entered.

### NOTE

Steps 3 and 4 above can be carried out from the main unit by turning and pushing the **MULTI JOG** control (11).

- 5 Repeat steps 3 and 4 above until the program is complete.

- 6 Press the **PLAY** key (18 or 21) to start playback at the first program step.

The display shows the track, the current time display, and the program step number.

While in programmed playback mode, using the **SKIP** keys (18) or the **MULTI JOG** control (11) moves backwards and forwards in the order set in the program.

Use the **PAUSE** key (19 or 20) to halt playback temporarily or the **STOP** key (17 or 19) to stop playback of the program.

If the **STOP** key is used, when playback is restarted, it starts from the first program step.

Clear the program by pressing **PLAY MODE** (10) until the display shows `Continue`. The program is also cleared when the disc tray is opened, and if the **STOP** key is pressed when playback is stopped in programmed order mode.

The programmed play order is not memorized when power is turned off.

If an attempt is made to enter more than 32 program steps, the message `PGM Full !` appears on the display.

## Repeat play

The unit can repeat the whole of the disc (or program) or the current track only or A-B repeat between two points.

The unit should be in playback, pause or stop mode.

- 1 With the unit in playback, pause or stop mode, continue to press the **REPEAT** key (4 or 4) so that the display shows `REPEAT 1` (the

**REPEAT 1 indicator lights) to repeat one track, or REPEAT ALL (the REPEAT ALL indicator lights) to repeat the whole disc or program.**

- 2 If playback has not started, restart it.

To cancel repeat mode, press the **REPEAT** key so that the display shows `REPEAT Off` and the **REPEAT** indicator goes out.

### A-B repeat mode

This mode allows looped playback between two points.

### NOTE

Selecting the A-B repeat mode is only possible using the remote control unit.

- 1 With the disc playing back, press the **A-B** key (5) at the point where the loop is to start. The **REPEAT** indicator lights and the **A-B** indicator flashes.

- 2 Press the **A-B** key again at the point where the loop will end. The **A-B** indicator lights in the display.

To cancel the A-B repeat mode:

- 1 Either press the **STOP** key, or press the **A-B** once more.

If you press the **STOP** key, playback stops, and if you press the **A-B** key, playback continues to the **B** (end) point of the loop and continues from there.

## 4 – Recording

Before you start recording using the CD-RW750, make sure that you understand the following key points:

- Once you have recorded on a CD-R disc, the data cannot be erased from it.

- You can add tracks to an unfinalized recordable disc. Once finalized, a CD-R disc is “fixed” and behaves in the same way as a pre-recorded disc. Finalized CD-RW discs, however, can be erased, refreshed and re-recorded.

---

### Input selection

---

To select the input to be recorded, press the **INPUT SELECT** key on the main unit (6).

Repeated presses of the key cycle through the following options:

ANALOG	Analog in
OPTICAL	Optical digital in
COAXIAL	Coaxial digital in

In the case of either the coaxial or optical inputs being selected, the boxed DIGITAL indicator shows on the display, and the appropriate indicator: COAXIAL or OPTICAL, lights on the display.

If the analog signal is selected, the boxed ANALOG indicator lights on the display.

**Analog recording level** The level of the analog signals received at the **ANALOG IN** jacks are controlled with the **INPUT** controls (14).

When recording analog signals, set the digital volume (see below) to 0dB.

**Digital recording level** The level of the digital signal may be controlled using the digital volume menu, as described below.

- 1 Press the **RECORD** key (20 or 14) to put the unit in record ready mode.
- 2 Repeatedly press the **MENU** key (9 or 6) until the display shows **Volume -XXdB** where -XX is the current setting.
- 3 Use the **MULTI JOG** control (11) or the **SKIP** keys (18) to adjust the input volume between -60dB and +18db (relative to the original input level). There is also a **∞** setting which represents a complete signal cut.

#### NOTE

*If digital direct is selected, as described below (“Digital direct” on page 23), the digital volume is bypassed and the menu item does not appear.*

---

### Input monitoring

When the unit is in record ready, or record mode, the input signal is output from the **OUT** jacks (digital and analog), allowing you to hear the input signal (note that in stop mode, no digital output is possible).

The meters also show the current signal level.

However, it is only possible to record, or to enter record ready mode, when a recordable disc is inserted. To allow monitoring of the input signal at other times, or when the unit is stopped, use the **MONITOR** key on the remote control unit (8).

The **RECORD** key (20) on the main unit also enables monitor mode from stop mode when there is no recordable disc in the unit (when there is a recordable disc in the unit, pressing the **RECORD** key enters record ready mode).

The word **MONITOR** appears on the display to show that the output signal is an echo of the input signal(s). The meters show the current input level.

Exit the monitor mode by using the **STOP** key.

---

### Frequency conversion

The sampling frequency for CDs is 44.1 kHz. The CD-RW750 will always record (and play back) CDs at this frequency.

However, if recording through a digital connection (either coaxial or optical) and the source has been recorded at a frequency other than 44.1 kHz, or is

being played back at a non-standard speed using a varispeed unit (more than 1% away from the standard), the CD-RW750’s internal frequency converter will automatically convert the incoming frequency to 44.1 kHz.

**NOTE**

If digital direct is selected, as described below (“Digital direct” on page 23), the frequency converter is bypassed. In this case, recording from digitally-con-

nected devices is only possible when the source frequency is 44.1 kHz. If an attempt is made to record from a digitally-connected source at a different frequency, the error message `Not F=44.1k!` is displayed.

---

## Basic recording

---

After selecting the input source (“Input selection” on page 18), it is possible to start recording.

The basic record procedure is as follows:

- 1 **Load a recordable disc into the unit. As the disc is loaded, the display shows TOC Reading.**  
  
When the disc has been loaded, the display indicators show CD-R, NO TOC, or CD-RW, NO TOC, as appropriate.
- 2 **Press the RECORD key (20 or 14). The unit enters record ready mode, as shown by the REC and pause indicators on the display. As the unit enters record ready mode, the display shows Now OPC (Optimum Power Control), as the unit prepares to record on the disc.**
- 3 **Adjust the level of the source, following the guidelines in “Input selection” on page 18.**

**NOTE**

The red OVER indicators on the meters should never light. Unlike analog equipment, digital audio units produce extremely unpleasant sounds when distorted, and there is no “headroom” after the 0 mark. If recording digitally from a commercially-produced CD, the volume set in the menu should be 0dB. This will maintain all the dynamic range of the source CD without clipping. Only boost the signal if the source is exceptionally quiet.

An analog signal input at nominal level, with no cut or boost from the volume controls, is equivalent to a reading of -16 dB on the meters.

- 4 **Press the PLAY key (18 or 21) or the PAUSE key (19 or 19) to start recording.**

Note that there is no need to “cue up” the recording position—the unit always finds the next available location on the disc and start recording to it.

- 5 **Press the PAUSE key (19 or 19) to pause recording temporarily. The pause indicator on the display shows this.**

Pressing PAUSE or PLAY again restarts recording with a new track number.

- 6 **Press STOP (17 or 19) to stop recording. When recording stops, the display shows PMA Writing (Program Memory Area) and the REC indicator flashes for a few seconds as the unit writes to the disc.**

When this message disappears, you must press the RECORD key (step 2) before restarting the recording. Recording restarts with a new track number.

**NOTE**

Remember that every time recording is paused or stopped, when recording is restarted, a new track will always be started. It is not possible to record in two “stages” within one track.

---

## Playing back tracks

Although an unfinalized disc cannot be played back on an ordinary CD player, the CD-RW750 can play back tracks that have been recorded.

Use the MULTI JOG control (11) or the SKIP keys (18) to select a track for playback.

---

## Time display while recording

While a recordable disc is being played back, the four time display modes available in normal playback as described in “Time display modes” on page 15: TOTAL, TOTAL REMAIN, track REMAIN and elapsed track time.

However, during recording there are fewer options available (obviously, the unit cannot see into the future and know how much time remains of the track which is being currently recorded!).

## 4 – Recording

When in record or record ready mode, repeated presses of the **DISPLAY** key (⑩ or ) cycle between displaying the remaining time left for recording on the disc (TOTAL REMAIN) and the elapsed time of the track currently being recorded (no indicator lit).

When playback is stopped at the start of a recordable disc, there are only two options available: TOTAL (the total time recorded so far on the disc) and TOTAL REMAIN (the total time available on the disc for further recording).

---

### Manual track division

It is possible to divide the recording into tracks “on the fly” while recording.

While recording is taking place, press the **RECORD** key (⑳ or ㉑). The current track number is incremented by one.

For details of automatic track division while recording, see “Automatic track division” on page 22.

#### NOTE

*According to the “Red Book” (the specification for audio CDs), a track cannot be less than four seconds in length, and there can be a maximum of 99 tracks on an audio CD. Bear these limitations in mind when adding track divisions.*

---

### Full disc

If recording a long program, when there is no space remaining on the disc for recording, as shown by the time display (see “Time display while recording” on page 19), just before the end of the disc is reached, the unit starts a fade-out over a few seconds (the display shows `Fade OUT`).

When the fade-out has finished, the display shows `Disc Full!!!` for a few seconds, and the unit

then goes into stop mode (the display shows `FM Writing`).

If the disc is a CD-RW, the final track can be erased, if required (see “Erasing tracks” on page 26) and the disc then finalized. If the disc is a CD-R, it must be finalized prior to use (see “Finalizing” on page 25).

---

## Advanced recording

These sections cover more advanced recording techniques which may be of use to you.

---

### Synchronized recording

Synchronized recording basically means that recording will begin automatically when a signal is received, and will stop when the signal ends.

Use the **SYNC REC** key (㉒ or ㉓) key to select the synchronization mode. The synchronization mode determines the automated start and stopping of recording when a signal is received.

Repeated presses of this key cycle through the following modes:

- `SYNC ALL`
- `SYNC 1`
- `SYNC OFF`

as shown in the display.

After the synchronization mode is selected, the record ready mode must then be entered (you cannot reverse the order of these steps).

Starting playback of the source automatically starts recording on the CD-RW750 if `SYNC ALL` or `SYNC 1` has been selected (see “Sync recording (start)” on page 21) and manual record start is disabled. If `SYNC OFF` is selected, the recording must be started manually.

The sync modes are related to the trigger level (as explained in “Setting the trigger level” on page 22).

## Sync recording (start)

The conditions under which an input signal is used as the trigger to start recording in the **SYNC ALL** and **SYNC 1** modes are:

- when recording digitally from a DAT deck, a digital track start signal is detected (the signal level is ignored):

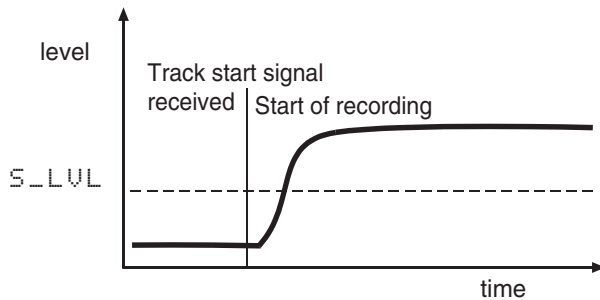

- when recording digitally from a CD or MD deck, a digital track start signal is received, and the signal level subsequently rises above the trigger level:

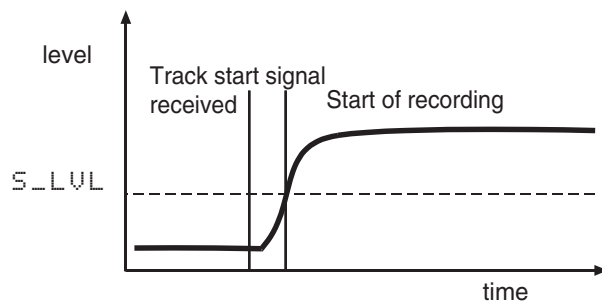

- when recording from any source other than the ones described above (that is, any digital source other than DAT, CD or MD, or any analog source), recording starts when the input signal level exceeds the trigger level.

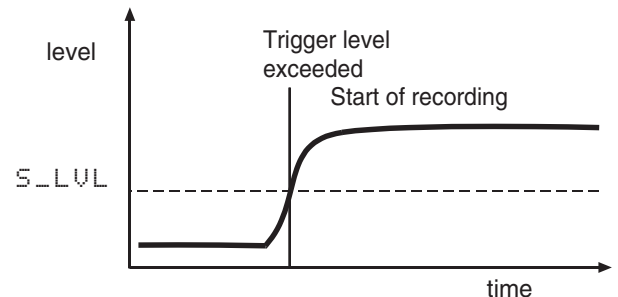

In this last case, if the signal level is already higher than the trigger level, recording starts immediately.

## Sync recording (stop)

**SYNC ALL** In the **SYNC ALL** mode, recording stops when the input level drops below the trigger level for more than six seconds.

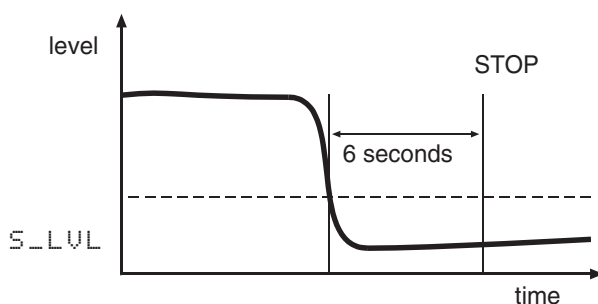

Also note that in this mode, the auto track function is enabled (see “Automatic track division” on page 22).

**SYNC OFF** Automatic synchronized record start and stop functions are disabled and must be performed manually.

**SYNC 1** In the **SYNC 1** mode, recording stops at the start of the next track (when the level of the first track has gone below the trigger level for less than six seconds and the level of the second track goes above the trigger level)

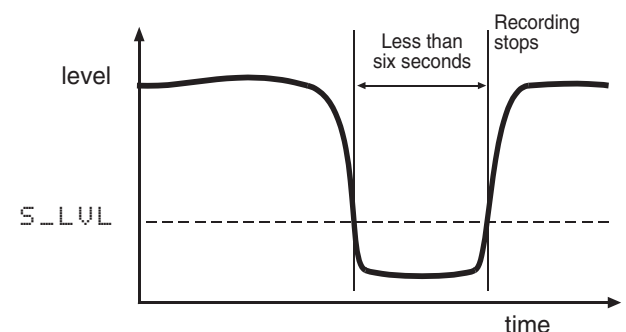

or

When the input level goes below the trigger level for more than six seconds (as in the **SYNC ALL** mode).

## 4 – Recording

### Setting the trigger level

The trigger level is set as below:

- 1 With a recordable disc loaded, press the **MENU** key (9 or 6) until the display shows: **S\_LVL >> -xxdB**, where **xx** is the current value.
- 2 Use the **MULTI JOG** control (11) or the **SKIP** keys (18) to change the value between **-24**, **-30**, **-36**, **-42**, **-48**, **-54**, **-60**, **-66**, and **-72 dB**.

Low numerical values of this setting (towards **-24**) mean that it takes a louder signal to trigger the start of the synchronized recording. A high numerical value (towards **-72**) means that a relatively quiet signal will trigger the start of recording.

If you set the value so that only high-level signals trigger recording, remember that this will not record the start of a piece with a slow fade-in:

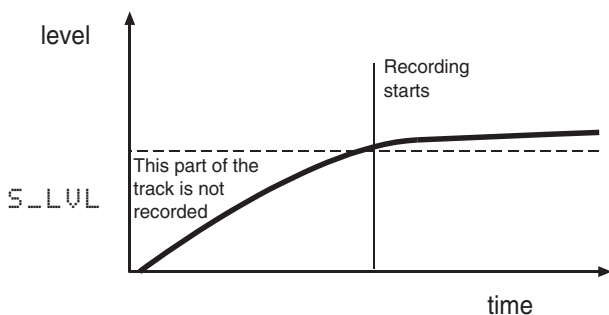

Also remember that when recording from an analog source, the threshold should be set so that it is higher than the “noise floor” (the base level of hiss, pops and crackles which may come from an older vinyl recording, for example). If the “noise floor” is higher than the threshold, a false start will occur:

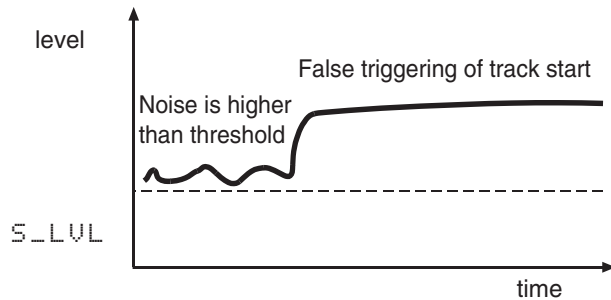

#### NOTE

When recording in sync mode, you may notice a slight delay between starting the source, and the CD-RW750 responding. This is due to the way in which the unit works, storing the data in a memory buffer before writing it to the disc. The resulting delay is therefore not a cause for concern—all audio data received between the start and end points will be recorded.

### Automatic track division

The trigger level, as set above (“Setting the trigger level” on page 22) can also be used to divide tracks if the A-TRACK (auto track) function is enabled.

When this function is enabled, the unit automatically inserts a track division in the recorded material when:

- recording digitally from MD, CD or DAT, an increment signal is detected and the sound level rises above the threshold:

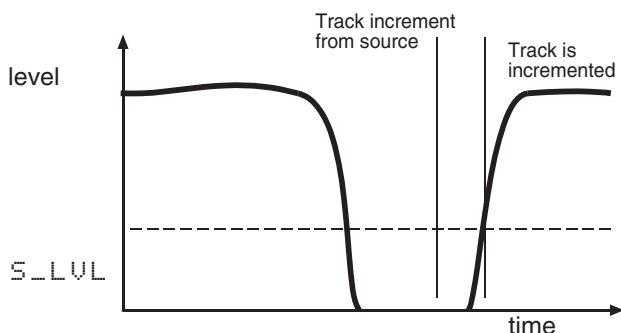

or

- increment signals are unavailable (e.g. analog recording or digital sources other than MD, CD or DAT) and the sound level has dropped below the threshold for more than two seconds, and sound has re-started

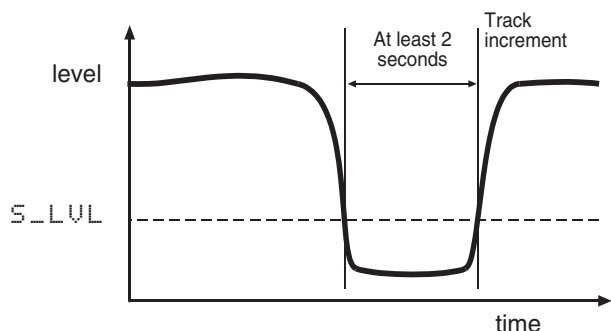

To enable or disable automatic track division:

- 1 With a recordable disc inserted, and with the unit in record ready mode, press the MENU key (9) or (6) repeatedly until `A_Track >XX` is shown, where `XX` may be ON or OFF.
- 2 Turn the MULTI JOG control (11) or use the SKIP keys (13) to change the value to ON or OFF.

The A-TRACK indicator at the top right of the display lights when the auto track function is enabled.

Automatic track division can be turned on or off while recording is taking place.

#### NOTE

When recording certain types of material (e.g. certain types of classical music or spoken word) through the

analog or non-DAT/CD/MD digital connections, since the track divisions are determined by relative silence, it is possible that spurious track divisions will be inserted. Under these conditions, it may be better to use manual track division (see below).

However, if recording through a DAT/MD/CD digital connection, the track number will be incremented only when a track division signal is received, followed by a rise in volume.

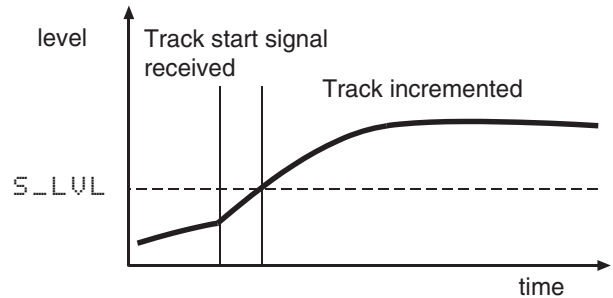

### Digital direct

As mentioned earlier, the digital direct mode bypasses some of the input circuitry of the CD-RW750 (the frequency converter and the digital level control) to write directly to the disc.

To enable or disable digital direct recording:

- 1 Ensure that the input source is set to DIGITAL (either COAXIAL or OPTICAL).
- 2 Press the DIGITAL DIRECT key (5) (main unit only). The display shows `D_Direct XX` where `XX` is ON or OFF.

- 3 Press the DIGITAL DIRECT key to toggle between ON and OFF.

When digital direct recording is enabled, the DIGITAL indicator in the display flashes slowly.

#### NOTE

As mentioned earlier, the digital direct feature bypasses the frequency converter. Recording is therefore only possible from sources recorded with 44.1 kHz sampling frequency.

### Rec mute function

The rec mute function allows instant cut-off of the input signal, and records four seconds of silence on the disc.

- 1 While recording is in progress, press the REC MUTE key (16).

The display shows `REC MUTE`, the meters stop displaying the current level and the monitored sound is cut.

- 2 After about four seconds, the unit enters record ready mode.

#### NOTE

This function is only available from the remote control unit. It is not possible to use this function with the main unit only.

### Fade-in and fade-out

To provide smooth beginnings and endings to recorded tracks, the unit provides fade facilities.

Fade-ins are from  $-\infty$  (silence) to the set input level ("Input selection" on page 18) and fade-outs go from the current input volume to silence.

The fade-in and fade-out times can be set independently in increments of one second, from 1 second to 24 seconds.

## 4 – Recording

To set the fade times:

- 1 Press the **MENU** key (9 or 6) repeatedly until the display shows **Fade IN > XXS**, where **XX** is the current fade-in time, in seconds.
- 2 Turn the **MULTI JOG** control (11) or use the **SKIP** keys (18) to change the value of the fade-in time.
- 3 Press the **MENU** key again so that the display shows **Fade OUT > XXS**, where **XX** is the current fade-out time, in seconds.
- 4 Turn the **MULTI JOG** control or use the **SKIP** keys to change the value of the fade-out time.

It is possible to set the fade-in time only (perform step 5 after step 2) or the fade-out time only (in step 1, press the **MENU** key until the fade-out time menu item is shown).

To perform a fade-in:

- 1 With a recordable disc loaded, press the **RECORD** key (20 or 14) so that the unit enters record ready mode.
- 2 Start the source material, and press the **FADER** key (22 or 11).

The display shows **Fade IN** for the time specified in the menu item above.

As the fade progresses, the monitored signal gradually becomes louder, reflecting the level recorded on disc.

To perform a fade-out:

- 1 While recording, press the **FADER** key (22 or 11).

The display shows **Fade OUT** for the time specified in the menu above.

As the fade progresses, the monitored signal gradually becomes quieter, reflecting the level recorded on disc.

- 2 When the end of the fade-out time is reached, the unit goes into record ready mode. Recording can be restarted with the **FADER** key or the **PLAY** or **PAUSE** keys.

The fade-in and fade-out times can be reset to new values while recording is in progress.

Fades are also possible in digital direct mode (“Digital direct” on page 23).



This section deals with the actions taken after recording: finalizing for CD-R and CD-RW discs, and erase operations for CD-RW discs.

Once finalized, CD-R discs are truly final—no more can be recorded on them. By contrast, CD-RW discs

can be “unfinalized” using the CD-RW750, i.e. their TOC can be deleted, and if there is space, further material can be recorded on them. Even if the disc is full, tracks can be erased following the unfinalize process, and new material can be recorded.

## Finalizing

As has been explained earlier (“Finalizing” on page 7), in order for a disc to become a standard CD, it must have a Table of Contents (TOC) written to it. This process is known as *finalizing*.

An unfinalized disc can always be distinguished on the CD-RW750 by the NO TOC indicator under the disc type on the display being lit when the disc is inserted.

To finalize a disc:

- 1 With the unfinalized (recordable) disc loaded, and the unit in stop mode, press the FINALIZE key (15 or 12).
- The display shows FINALIZE OK?.
- 2 To start the finalizing process, press the MULTI JOG control (11) or press the ENTER key (7).

- 3 If you do not want to proceed with the finalizing process, press any other key (such as the STOP key).
- 4 If finalization has been chosen, the display changes. The NO TOC indicator goes out, and the word TOC and the REC indicator flash in the display. The unit starts counting down from a time shown on the display (depending on the disc and material, this value will be between 50 seconds and 1 minute 30 seconds).
- 5 After finalization, a CD-RW NO TOC changes to CD-RW and a CD-R NO TOC changes to a CD.

### NOTE

Although CD-R discs finalized on the CD-RW750 may be replayed on ordinary CD players, remember that finalized CD-RW discs may not play on CD players.

## Unfinalizing CD-RW discs

If a CD-RW disc has been finalized, it is possible to erase the Table of Contents in the following way:

- 1 With the finalized disc loaded and the unit in stop mode, press the ERASE key (16 or 13).
- 2 If the display does not show the word UNFINALIZE?, turn the MULTI JOG control (11) or use the SKIP keys (18) until it is displayed.
- 3 To start the unfinalizing process, press the MULTI JOG control (11) or press the ENTER key (7).

- 4 If you do not want to proceed with the unfinalizing process, press any other key (such as the STOP key).
- 5 If unfinalization has been chosen, the NO TOC indicator starts flashing in the display, and the word ERASE also starts flashing. The unit starts counting down from a time shown on the display (depending on the disc and material, this value will be between 50 seconds and 1 minute 30 seconds).
- 6 After unfinalization, a CD-RW indicator changes to a CD-RW NO TOC indicator.

## Erasing

Unfinalizing (described above) is a special case of erasing a disc. It is also possible to erase a track or tracks, starting with the last-recorded track, a whole disc, or to “refresh” a disc.

### NOTE

Erase procedures are possible only on a CD-RW disc. Even if a CD-RW disc has been finalized, selecting an erase procedure will automatically unfinalize it prior to erasure. The disc may then have to be re-finalized. Remember that it is not possible to perform any erase procedures on a CD-R disc.

## 5 – After recording

### Erasing tracks

It is possible to erase the last recorded track, the last two recorded tracks, the last three recorded tracks, etc. It is not, however, possible to erase tracks in the “middle” of the disc.

- 1 With the disc loaded, and the unit in stop mode, press the ERASE key (Ⓜ or Ⓝ).
- 2 If the display does not show ERASE XX-XX?, where XX is the number of the last track recorded on the disc, turn the MULTI JOG control (Ⓜ) or use the SKIP keys (Ⓝ) until it is displayed.
- 3 Turn the MULTI JOG control or use the SKIP keys to change the number of the first track to be erased. The highest value that this number can take is the last track recorded (e.g. if 17 tracks have been recorded on the disc, 17-17 means that the last track only, 17, will be erased). The lowest value that this number can take is 2 (if this number was 1, the whole disc would be erased, as described below).

#### NOTE

If only one track has been recorded on the disc, only the “erase disc” option (“Erasing a whole disc” on page 26) is available.

- 4 When the range of tracks to be erased has been selected, press the MULTI JOG control or press the ENTER key (Ⓜ).

#### NOTE

This operation cannot be undone. If you are going to erase a track or tracks, make sure that they are recordings that you really want to erase!

- 5 If you do not want to proceed with the erase operation, press any other key (such as the STOP key).
- 6 If the erase operation has been selected, the word ERASE flashes on the display, and the timer starts counting down from 0:20 (20 seconds).
- 7 At the end of the countdown period, the word Complete appears briefly on the display, and the display returns to the track/time display.

### Erasing a whole disc

When you want to erase a whole disc (all the tracks on a disc), follow the procedure below:

- 1 With the disc loaded, and the unit in stop mode, press the ERASE key (Ⓜ or Ⓝ).
- 2 Turn the MULTI JOG control (Ⓜ) or use the SKIP keys (Ⓝ) until the display shows ERASE DISC?.
- 3 To erase the contents of the disc, press the MULTI JOG control or press the ENTER key (Ⓜ).

#### NOTE

This operation cannot be undone. If you are going to erase a disc, make sure that it contains only recordings that you really want to erase!

- 4 If you do not want to proceed with the erase operation, press any other key (such as the STOP key).
- 5 If the erase operation has been selected, the word ERASE flashes on the display, and the timer starts counting down a time value shown on the display.
- 6 At the end of the countdown period, the word Complete appears briefly on the display, and the display returns to the track/time display.

### Refreshing a disc

If a CD-RW disc has been corrupted at any point (e.g. power has been cut off in the middle of a finalize operation, etc.), or has been used in a computer or another piece of equipment that makes it unreadable,

it is possible to “refresh” the disc to make it usable again. This is equivalent to formatting a disk on a computer to prepare it for use. This operation destroys all data on the disc.

- 1 With the disc loaded, and the unit in stop mode, press the **ERASE** key (Ⓔ or Ⓕ).
- 2 Turn the **MULTI JOG** control (Ⓘ) or use the **SKIP** keys (Ⓖ) until the display shows **DISC REFRESH**.
- 3 To refresh the disc, press the **MULTI JOG** control or press the **ENTER** key (Ⓙ).
- 4 If you do not want to proceed with the refresh operation, press any other key (such as the **STOP** key).
- 5 If the erase operation has been selected, the word **ERASE** flashes on the display, and the timer starts counting down. The refresh operation typically takes around 40 minutes or so.
- 6 At the end of the countdown period, the word **Complete** appears briefly on the display, and the display returns to the track/time display (of course, there are no tracks, and the disc is as the start, with the total time of the disc available for recording).

**NOTE**

*This operation cannot be undone. If you are going to refresh a disc, make sure that it contains only recordings that you really want to erase!*

---

## Titling (CD TEXT)

---

The CD-RW750 allows you to add titles to discs and/or tracks on the disc which can be read and displayed by suitably-equipped players (naturally, the CD-RW750 is itself such a player, capable of reading and displaying CD TEXT—see “Simple playback operations” on page 15 and “Time display modes” on page 15).

Up to 23 alphanumeric characters (including space) may be written in a title. One title may be written per disc and per track (for example, it is not possible to enter the disc title and artist as separate titles).

**NOTE**

*Titling can only be carried out on an unfinalized recordable disc, and the titles only become readable by a player after the disc has been finalized.*

This is a menu option, accessed in the following way (this describes the operation from the main unit—you can also use the **SKIP** keys of the remote control unit rather than turning the **MULTI JOG** control, and the **ENTER** key of the remote control unit rather than pressing the **MULTI JOG** control).

- 1 Press the **MENU** key until the display shows **CD TEXT?**. Press the **MULTI JOG** control.
- 2 The display shows **T\_EDIT DISC?**. To edit the disc title, press the **MULTI JOG** control, or to start editing the track titles, turn the control so that the display shows **T\_EDIT>01Tr**.  
Continue turning the control to select the track whose title will be edited, and press it
- when the number of the track whose title will be edited is displayed.
- 3 Use the **MULTI JOG** control both to enter characters (uppercase and lowercase letters, numbers, and symbols) and to move the entry cursor.  
Change between these two cursor modes with the **FADER (JOG MODE)** key,
  - When the **MULTI JOG** is used for data entry, the cursor is a flashing underline (changing to data entry mode inserts a space at the cursor). Turn the control to select the character, and push it to confirm the entry and move to the next character position.
  - When the **MULTI JOG** is used for cursor movement, the cursor is a steadily-lit underline.
  - Use the **ERASE/DEL** key to delete characters at the cursor.
  - Change between uppercase and lowercase letters using the **DISPLAY** key. When uppercase is selected, **CAPS** is shown in the display.
- 4 Press the **FINALIZE/YES** key to finish editing the title. The display shows **Writing** followed by **Write OK** and returns to **T\_EDIT**. From this step, you can then select another title to edit.
- 5 Press the **STOP** key when all titles are finished.
- 6 Finalize the disc (see “Finalizing” on page 25).

## 6 – Reference and specifications

### Troubleshooting

Symptom	Possible cause and remedy
No sound on playback (the disc is playing and the time display is incrementing)	The connections from the CD-RW750 to the amplifier system have not been made properly, or the input source selector is not at the correct position.
No meter indication when a source is input	Analog and/or digital volume ("Input selection" on page 18) is set too low. The signal is being input through an unselected input source.
D-IN UNLOCK!	A digital input source has been selected, but the source is not connected or is not switched on.
Cannot record on a disc (pressing <b>RECORD</b> shows MONITOR)	A finalized disc has been inserted. Use an unfinalized recordable disc.
PGM Full !	An attempt has been made to create more than 32 program steps.
Disc Full! or Cannot Rec!	There is no space on the disc, or no tracks are available, or a general recording error has occurred.
Not FS 44.1k!	You are trying to do digital direct recording from a source which has not been recorded at 44.1 kHz ("Digital direct" on page 23).
Disc Error	The disc is bad. If it is a CD-RW disc, you may refresh it ("Refreshing a disc" on page 26), otherwise replace the disc.
Erase Error!	An error has occurred while trying to erase the disc.
The display suddenly shows PMA Writing	Either the disc is full (this message will be prefaced by Disc Full!!! ("Full disc" on page 20) or an attempt has been made to write more than 99 tracks.
Rec Error	General recording error. This may be caused by vibration or a shock during recording, for example, or may be the result of a bad disc. Try recording again with the same disc. If the message appears again, try a different disc.
No OPC Area!	Appears only with CD-R discs. The OPC area is full, and no further recording is possible on this disc. Finalize the disc.
System Err! Need Repair!	These messages indicate an internal error in the unit. Consult your dealer or distributor regarding repair facilities.
No CD-DA	Shown when the input source is incompatible (e.g. the source is a CD-ROM, or the digital audio format is AES3).

### Specifications

#### Audio performance

Recording media type	CD-R, CD-RW, CD-RDA, CD-RWDA
Recording resolution	16-bit linear
Recording sampling frequency	44.1 kHz (playback $\pm 0.5$ dB, recording $\pm 1$ dB)
Frequency converter input	32 kHz — 48 kHz
Frequency response	20 Hz — 20 kHz $\pm 1$ dB (playback), +1 dB, -1.5 dB (recording)
S/N ratio	>92 dB (playback) >88 dB (recording)
Dynamic range	>92 dB (playback) >88 dB (recording)
Total harmonic distortion	<0.008% (playback) <0.01% (recording)
Channel separation	>80 dB (playback : 1 kHz) >75 dB (recording : 1 kHz)
Wow & flutter	Unmeasurable (< 0.001%)

### Audio specifications

<b>ANALOG OUTPUTS</b>		Unbalanced RCA
Nominal output level		-10 dBV (FS -16 dB)
Maximum output level		+6 dBV
Output impedance		800 $\Omega$ (unbalanced)
<b>ANALOG INPUTS</b>		Unbalanced RCA
Nominal input level		-10 dBV (FS -16 dB)
Maximum input level		+ 6dBV
Input impedance		33 k $\Omega$ (unbalanced)
<b>PHONES</b> output		6 mm (1/4") stereo
Output level		35 mW + 35 mW (into 32 $\Omega$ )
<b>DIGITAL INPUT</b>	<b>COAXIAL</b>	RCA pin, IEC-60958 TYPE II
	<b>OPTICAL</b>	TOSLINK, IEC-60958 TYPE II
<b>DIGITAL OUTPUT</b>	<b>COAXIAL</b>	RCA pin, IEC-60958 TYPE II
	<b>OPTICAL</b>	TOSLINK, IEC-60958 TYPE II

### Physical specifications

Voltage requirements	USA/Canada 120 VAC, 60 Hz U.K./Europe 230 VAC, 50 Hz Australia 240 VAC, 50 Hz
Power consumption	17 W
Peak inrush current	1.1A (230V)
Applicable Electromagnetic Environment	E4
Dimensions w x h x d	482 x 93 x 312 (mm) 19 x 3.9 x 12.3 (in)
Weight	6.7 kg (14.75 lb)
Supplied accessories	RC-RW750 remote control unit 2 x type 3 (AAA) batteries Rack mounting kit

### Dimensional drawing

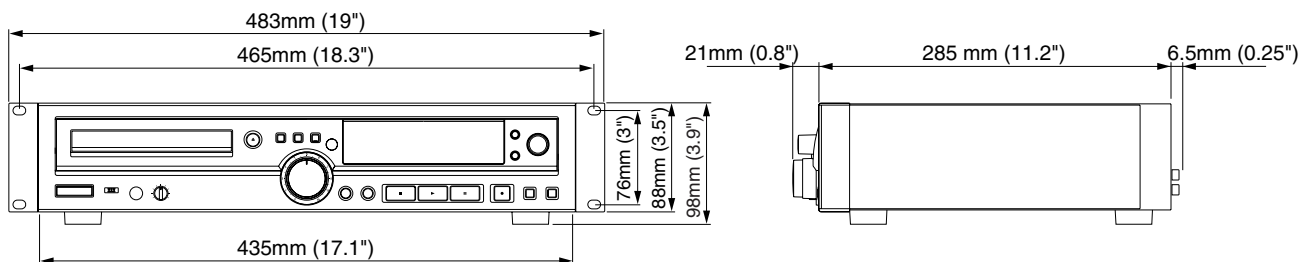

# **TASCAM**

## **TEAC Professional Division**

# **CD-RW750**

### **TEAC CORPORATION**

Phone: +81-422-52-5082

3-7-3, Nakacho, Musashino-shi, Tokyo 180-8550, Japan

[www.tascam.com](http://www.tascam.com)

---

### **TEAC AMERICA, INC.**

Phone: +1-323-726-0303

7733 Telegraph Road, Montebello, California 90640

[www.tascam.com](http://www.tascam.com)

---

### **TEAC CANADA LTD.**

Phone: +1905-890-8008 Facsimile: +1905-890-9888

5939 Wallace Street, Mississauga, Ontario L4Z 1Z8, Canada

[www.tascam.com](http://www.tascam.com)

---

### **TEAC MEXICO, S.A. De C.V**

Phone: +52-555-581-5500

Campesinos No. 184, Colonia Granjes Esmeralda, Delegacion Iztapalapa CP 09810, Mexico DF

[www.tascam.com](http://www.tascam.com)

---

### **TEAC UK LIMITED**

Phone: +44-1923-438880

5 Marlin House, Croxley Business Park, Watford, Hertfordshire. WD1 8TE, U.K.

[www.tascam.co.uk](http://www.tascam.co.uk)

---

### **TEAC DEUTSCHLAND GmbH**

Phone: +49-611-71580

Bahnstrasse 12, 65205 Wiesbaden-Erbenheim, Germany

[www.tascam.de](http://www.tascam.de)

---

### **TEAC FRANCE S. A.**

Phone: +33-1-42-37-01-02

17 Rue Alexis-de-Tocqueville, CE 005 92182 Antony Cedex, France

[www.tascam.fr](http://www.tascam.fr)

---

### **TEAC AUSTRALIA PTY.,LTD. A.B.N. 80 005 408 462**

Phone: +61-3-9672-2400 Facsimile: +61-3-9672-2249

280 William Street, Port Melbourne, Victoria 3000, Australia

[www.tascam.com.au](http://www.tascam.com.au)

---

### **TEAC ITALIANA S.p.A.**

Phone: +39-02-66010500

Via C. Cantù 11, 20092 Cinisello Balsamo, Milano, Italy

[www.teac.it](http://www.teac.it)

---